

# Night Guard 1 Series

LED Area Light

CE CB LVD   EMC

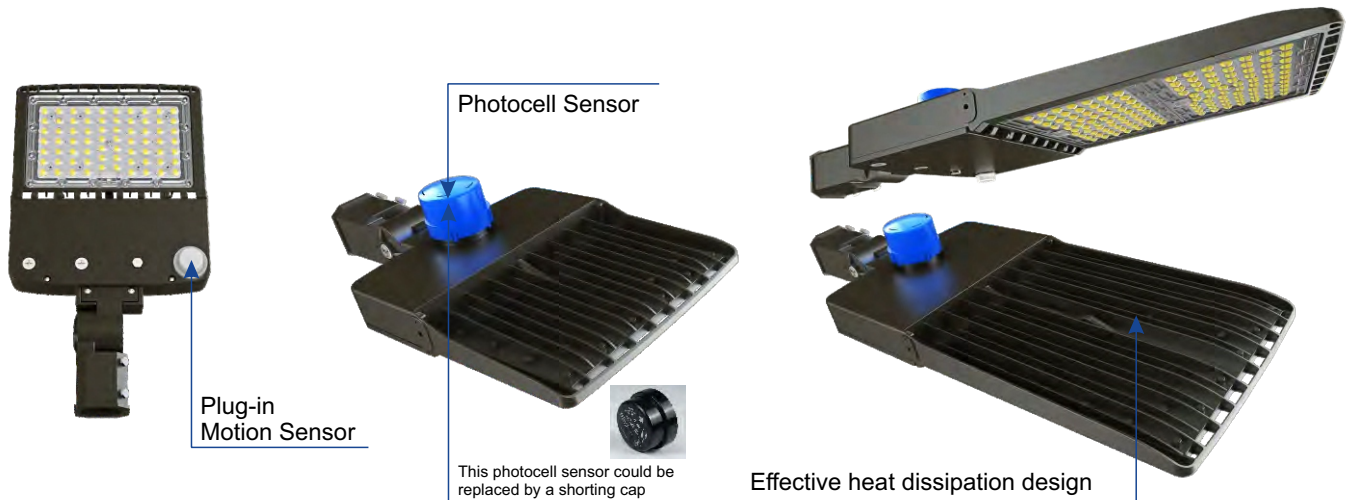

## Product Overview

The Shoebox Light is an impressive blend of performance, value and aesthetics. It is available in a wide range of lumen packages to meet a variety of outdoor lighting needs, including campus and parking lot applications. The area luminaire can be combined with a complete, architecturally sophisticated LED family to create a total solution for commercial, municipal, retail, education and hospitality applications. The optional visual comfort optic distributes light through a non-pixelated light source that produces uniform, eye-friendly illumination with minimal glare. The high-performance, IP66-rated luminaire delivers a minimum of 140 lumens per watt, resulting in significant energy savings while ensuring long service life in the field.

## Features:

- ◆ Power adjustable: 50/80/100W; 80/100/150W; 100/150/200W; 150/200/250W; 200/250/300W.
- ◆ CCT tunable: 2700K-6500K.
- ◆ Motion sensor and daylight sensor available.
- ◆ Lumen packages ranging from 7000lm to 42,000lm.
- ◆ Comes with multiple bracket options, 5 year warranty on the entire luminaire.
- ◆ 10/20 kV surge suppression standard
- ◆ Available in Type II, Type III, Type IV, and Type V optics

Technical Information:

Model	F1	F3	F5
<b>Wattage(Single)</b>	100W	150W; 200W	300W
<b>Wattage(Tunable)</b>	50W/80W/100W	80W/100W/150W; 100W/150W/200W	150W/200W/300W
<b>Light Efficiency</b>	140 lm/W		
<b>Input Voltage</b>	AC100-277V/AC100-347V		
<b>Power Frequency</b>	50/60Hz		
<b>Power Efficiency</b>	94%		
<b>Power Factor</b>	0.95		
<b>Heat Radiator</b>	Die-Cast Aluminum		
<b>Beam Angle</b>	T2 T3 T4 T5		
<b>LED Type</b>	3030/2835		
<b>CRI</b>	70 / 80		
<b>CCT(Tunable)</b>	2700N-6500N		
<b>Working Life-span</b>	> 50000 hours		
<b>IP Rating</b>	WET LOCATION AND IP66		
<b>Surge Protection</b>	10/20 kV(optional)		
<b>Carton Dimensions(SF Bracket)</b>	577x282x146mm 22.7x11.1x5.7inch	625x380x130mm 24.6x15x5.1inch	890x405x125mm 35x16x5inch
<b>Carton Dimensions(AAM Bracket)</b>	515x282x146mm 20.3x11.1x5.7inch	645x380x130mm 25.4x15x5.1inch	890x405x125mm 35x16x5inch
<b>Net Weight</b>	3.6kg/7.9lbs	5.2kg/11.5lbs	6.5kg/14.3lbs
<b>Gross Weight</b>	4.8kg/10.6lbs	6.7kg/14.8lbs	8.5kg/18.7lbs

Photometry:

T2M Type II Medium

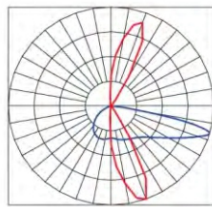
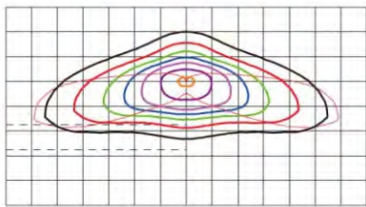

T3M Type III Medium

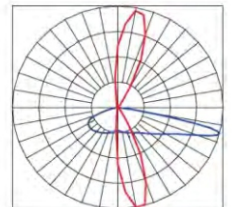
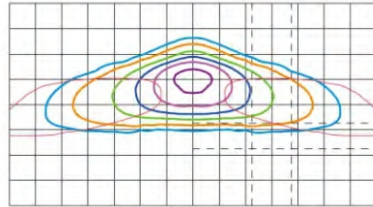

T4S Type IV Short

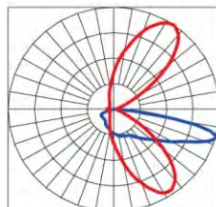
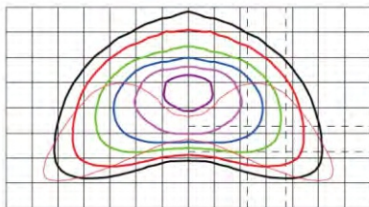

T5M Type V Medium

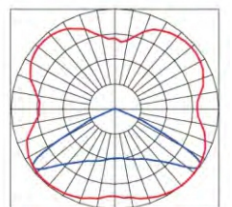
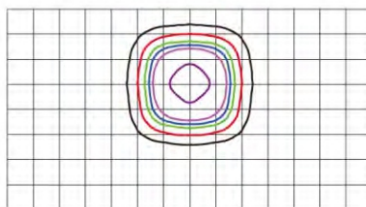

Catalog Number Logic:

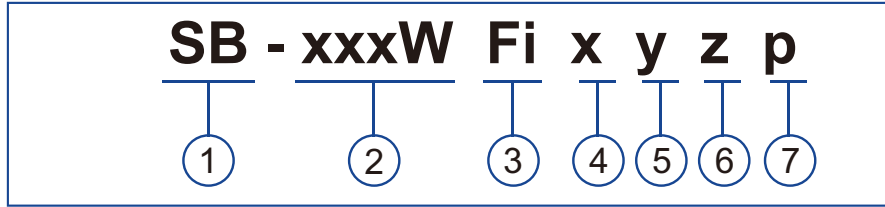

- ① **PRODUCT NAME**
  - ◆ Shoe Box
- ② **WATTAGE**
  - ◆ 50W/80W/100W
  - ◆ 80W/100W/150W
  - ◆ 100W/150W/200W
  - ◆ 150W/200W/300W
- ③ **MODEL NO.**
  - ◆ F1/F3/F5
- ④ **DIMMING**
  - ◆ N=non-dimmable
  - ◆ D=dimmable
- ⑤ **CCT**
  - ◆ 27=2700K
  - ◆ 30=3000K
  - ◆ 40=4000K
  - ◆ 50=5000K
  - ◆ -----
  - ◆ 65=6500K
- ⑥ **LIGHT DISTRIBUTION**
  - ◆ z can be T2, T3, T4, T5
- ⑦ **Driver**
  - ◆ p can be Z, M, F, L, S, D

Dimension:

Unit: inch/mm

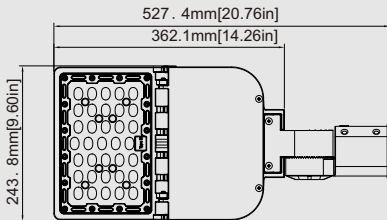

F1

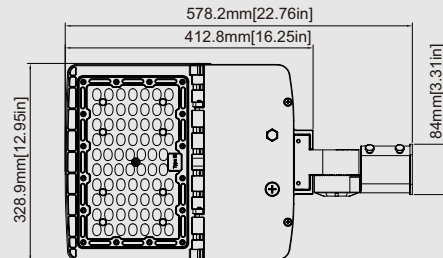

F3

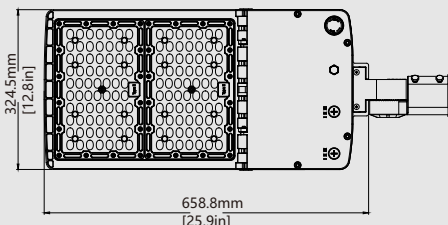

F5



U Shaped Bracket Installed

Accessories:



Adjusted Arm Mounting Kit



Arm Mounting Kit



Slip Fitter



Trunnion Mounting Kit



Bracket

Installation Guidance:

1. Tighten 2 x Fixing screws by spanner, ensure to add star washer avoid the screws will loose.
2. Turn on the power to test shoe box light, but you need to cover the sensor window if there is sunshine.

Arm Mounted

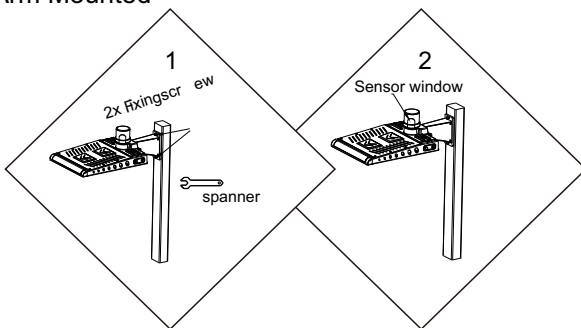

Drill holes on the square pole corresponding to the holes on the arm, and use the bolt and nut plate to fix the fixture to the pole tightly.

Connect the AC wire of the fixture and tighten the water-proof gasket and cover plate on the arm by screws, then power on.

Slip Mount

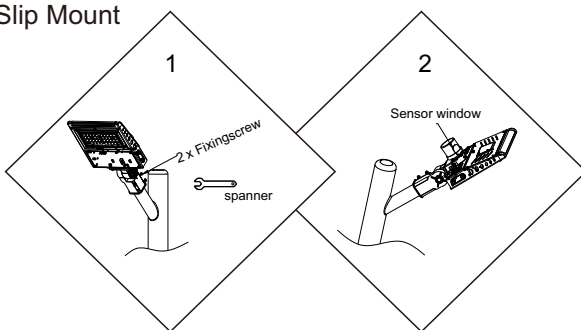

Slip fitter mounts are very easy to install as they usually slide over standard 2 3/8-inch lighting poles.

The biggest advantage of slip fitter mounts is that they give you the ability to angle the light inwards.

They have adjustable heads. They enable you to move the heads to the position you desire.

Trunnion Mounted

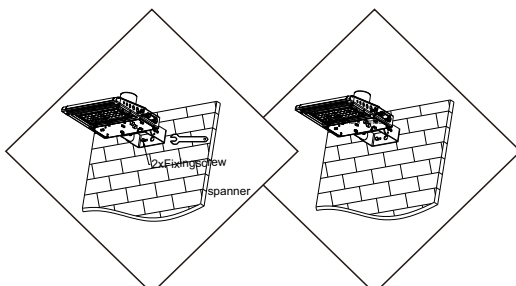

These are versatile mounts and fit at the bottom of the LED Shoe Box lights.

They borrow their design from the mounts that are generally used on flood lights (yoke mounts).

They are the go-to mounts for unique applications.